

JOLLY

Raccoglitrice portata

Recogedora mecànica aplicada al elevador

Mechanical mounted harvester

Récolteuse mécanique à élévateur



**JOLLY 1500
JOLLY 1800
JOLLY 2500
JOLLY 2800**



nocciole
avellanas
hazelnuts
noisettes



castagne
Castañas
chestnuts
châtaignes



noci
walnuts
noix



mandorle
almonds
almonds
amandes

JOLLY 1500



Peso
(peso, weight, poids)
490kg

Raccolta
(cosecha, harvesting, récolte)
150cm

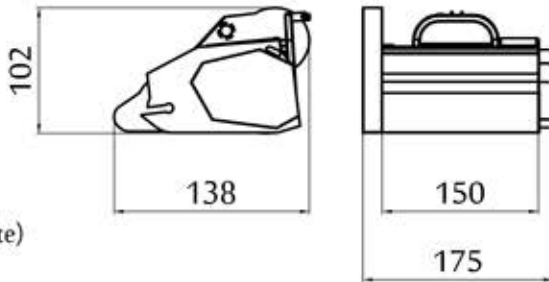

JOLLY 1800



Peso
(peso, weight, poids)
550kg

Raccolta
(cosecha, harvesting, récolte)
180cm

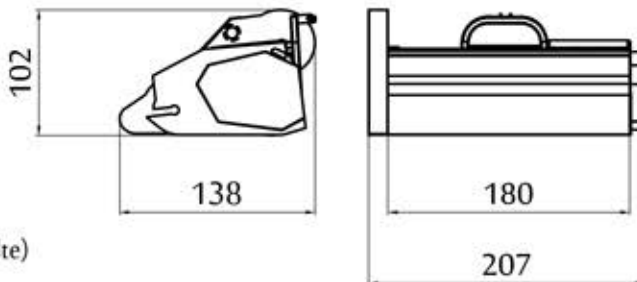

Jolly 1500/1800

un solo vaglio
sólo tamiz
only sieve
seulement tamis

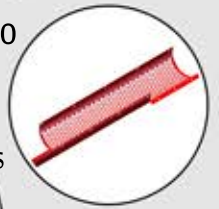

La macchina raccogliitrice Jolly è una macchina da installare su tutti i tipi di trattori, per la raccolta di nocciole, noci, castagne, olive, mandorle, caffè e tutti i frutti a terra. A differenza delle tradizionali macchine ad aspirazione, la Jolly raccoglie la frutta a terra in modo meccanico, attraverso una spazzola rotante anteriore, essa trasporta il prodotto verso coclee e vagli che selezionano il frutto dal prodotto di scarto. A fine ciclo tutti i frutti sono spinti da un getto d'aria verso un carrello o un contenitore. Terreni bagnati o erbosi non comportano alcuna difficoltà per la macchina. La raccolta con macchine Jolly riduce l'emissione di polveri in aria e i consumi di carburante (lavora a bassi regimi di giri). È adatta a estensioni di piccole e medie dimensioni. La macchina può essere collegata sull'attacco a tre punti sia anteriore che posteriore di qualsiasi trattore e il moto può essere dato sia dalla presa di forza a 540 rpm, 1000 rpm, sia attraverso un impianto idraulico composto da serbatoio, olio, pompa, moltiplicatore e radiatore. Esistono diverse versioni della Jolly: normale, super e eco.

La máquina recogedora Jolly es una máquina que se instala en todos los tipos de tractores, para la recogida de avellanas, nueces, castañas, aceitunas, almendras, café y todos los frutos de la tierra. A diferencia de las máquinas tradicionales, el Jolly recoge la fruta en el suelo de una manera mecánica, a través de un frente cepillo giratorio, que lleva el producto hacia los sinfines y cribadoras que seleccionan la fruta de producto de desecho. Al final del ciclo de todos los frutos son impulsados por un chorro de aire hacia un carro o contenedor. Suelo mojado o hierba no implican ninguna dificultad para la máquina. Máquina Jolly reduce la emisión de polvo en el aire y el consumo de combustible (obras en bajas rpm). Es conveniente para las extensiones de tamaño pequeño y mediano. La máquina se puede aplicar a los tractores con enganches a tres puntos sea delantero que trasero y el movimiento puede ser determinado tanto por la toma de fuerza a 540 rpm, 1000 rpm, ya sea a través de un sistema hidráulico que consiste en el tanque, la bomba de aceite, moltiplicador y radiador. Hay varias versiones de Jolly: normal, super y eco.



nocciole

avellanas
hazelnuts
noisettes



castagne

castañas
chestnuts
châtaignes



noci

walnuts
Walnüsse
noix



mandorle

almonds
Almondn.
amandes

Jolly 2500/2800

due vagli
dos tamices
two sieves
deux tamis



The harvesting machine Jolly is a machine to be installed on all types of tractors, for the harvesting of hazelnuts, walnuts, chestnuts, olives, almonds, coffee and all the fruits on the ground. Unlike traditional harvesting machines, the Jolly harvests the fruit on the ground in a mechanical way, through a rotating brush front, it carries the product towards the augers and sieves which select the fruit from waste product. At the end of the cycle all the fruits are driven by a jet of air towards a cart or container. Wet ground or grass do not involve any difficulties for the machine. Harvesting machines Jolly reduces the emission of dust into the air and fuel consumption (works at low rpm). It is suitable for extensions of small and medium size. The machine is attachable to tractors with three point linkage both anterior and posterior and the motion can be given by both the PTO at 540 rpm, 1000 rpm, either through a hydraulic system consisting of tank, oil pump multiplier and radiator. There are several versions of Jolly: normal, super and eco.

La machine de récolte Jolly est une machine à être installée sur tous les types de tracteurs, pour la récolte de noisettes, noix, châtaignes, olives, amandes, café et tous les fruits sur le terrain. Contrairement aux machines d'aspiration traditionnelles, le Jolly recueille les fruits sur le terrain d'une manière mécanique, à travers un front de brosse rotative, il transporte le produit vers les vis et les agents de contrôle qui sélectionnent le fruit de déchet. A la fin du cycle, tous les fruits sont entraînés par un jet d'air vers un panier ou d'un récipient. Sol humide ou de l'herbe ne comportent pas de difficultés pour la machine. Machines de récolte Jolly réduisent l'émission de poussières dans l'air et la consommation de carburant (œuvres à bas régime). Il est adapté pour les extensions de petite et moyenne taille. La machine peut être appliquée sur tracteurs avec attelage à trois points, soit antérieur que postérieur, et la motion peut être donnée à la fois par la prise de force à 540 rpm, 1000 rpm, soit par un système hydraulique composé de réservoir, pompe à huile, multiplicateur et radiateur. Il existe plusieurs versions de Jolly: normal, super et eco.

JOLLY 2500

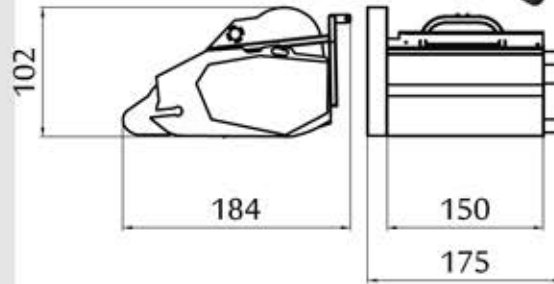

Peso
(peso, weight, poids)
590kg

Raccolta
(cosecha, harvesting, récolte)
150cm

JOLLY 2800

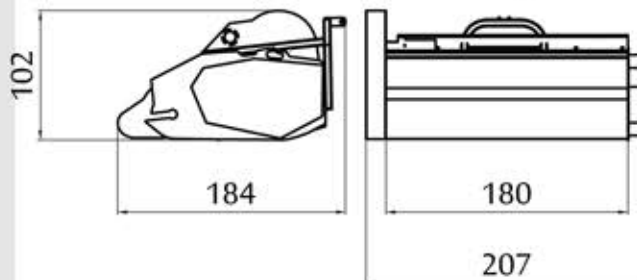

Peso
(peso, weight, poids)
650kg

Raccolta
(cosecha, harvesting, récolte)
180cm



nocciole
avelanas
hazelnuts
noisettes



castagne
cassias
chestnuts
châtaignes





noci
nueces
walnuts
noix



mandorle
almonds
almonds
amandes

 Tutte le macchine Jolly sono disponibili in tre diverse versioni: eco, normale e super. La differenza tra normale e super consiste nel musetto della macchina: la super monta un musetto con griglia per una pulizia più efficace del prodotto. Le versioni eco, invece, sono macchine economiche che adottano una griglia fissa a differenza dei quattro rulli rotanti interni.

 All machines Jolly are available in three different versions: eco, normale and super. The difference between normale and super is in the nose of the machine: on the super is installed nose with grille for a more effective cleaning of the product. The versions eco, instead, are economic machines which adopt a fixed grid unlike the four rotating rollers interior.

 Todas las máquinas Jolly están disponibles en tres versiones diferentes: eco, normale y super. La diferencia entre lo normale y súper está en la parte delantera: la super está equipada con una parrilla en la parte delantera para una limpieza más eficaz del producto. Las versiones eco son máquinas económicas que adoptan una rejilla fija a diferencia de los cuatro rodillos giratorios interior.

 Toutes les machines Jolly sont disponible en trois versions différentes: eco, normale et super. La différence entre le normale et super est dans l'avant de la machine: super équipée avec une grille à l'avant pour un nettoyage plus efficace du produit. Les versions eco, au contraire, sont des machines économiques qui adoptent une grille fixe contrairement à la quatre rouleaux rotatifs intérieur.

ECO



NORMALE

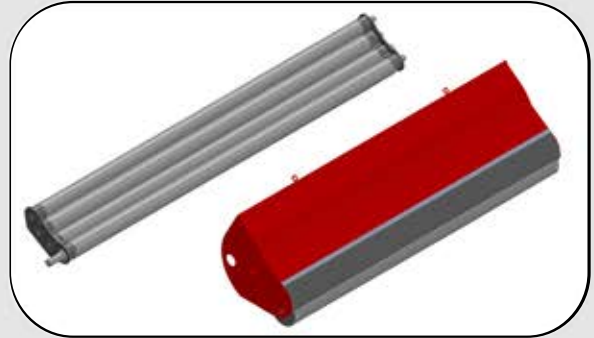

SUPER

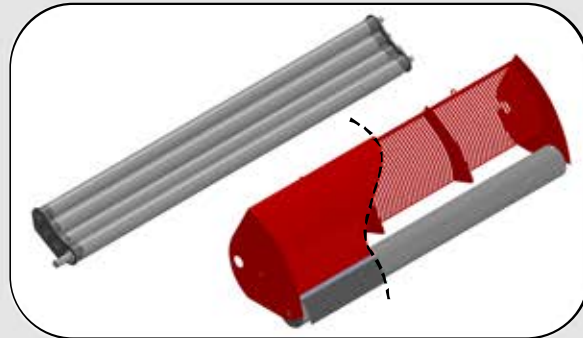

Accessori - Accesorios - Accessories - Accessoires



Spazzola laterale idraulica
Cepillo lateral hidráulico
Hydraulic lateral brush
Brosse latérale hydraulique



Rullo anteriore
Rodillo delantero
Front roller
Rouleau avant

Su tutti i trattori è possibile installare la presa di forza anteriore con kit idraulico (serbatoio, pompa, moltiplicatore e radiatore)

En todos los tractores puede instalar la toma de fuerza con kit hidráulico en frente: tanque, bomba, multiplicador, radiador

On all tractors you can install the PTO in front with hydraulic kit: tank, pump, multiplier, radiator

Sur tous les tracteurs, vous pouvez installer la prise de force à l'avant avec le kit hydraulique: réservoir, la pompe, multiplicateur, radiateur

